

DESCRIPTION

The **HCS621GXY** hot & cold stage is designed for applications where both thermal and atmospheric control is critical. Using a silver heating and cooling block, this stage provides a wide temperature range with exceptional thermal uniformity. The gas-tight chamber provides a controllable environment to prevent condensation, provide defrosting, prevent sample oxidation, or to control pressure. This heating and cooling stage also features XY positioning, making it possible to position samples while also maintaining a controlled atmosphere.



KEY FEATURES

Wide Temperature Range

-190°C to 600°C (with optional [LN2 cooling accessory](#))

XY Positioning

Position sample while maintaining a vacuum chamber with the optional XY positioner. With greater flexibility, sample area accessibility, and precision control, this option is optimal for use with a rotational stage on a polarizing microscope due to the directional nature of polarization

Gas-tight Chamber

Sealed chamber allows for positive pressure gas purge up to 0.5Bar and very rough evacuation down to 1mBar. Apply a dry-inert gas purge to prevent condensation while cooling, or to prevent oxidation while heating. Humidity control is also possible with Instec's RHC01 humidity controller (available by request).

Accuracy and Stability

A pt100 platinum RTD sensor is embedded into the sample heating and cooling block to guarantee high temperature accuracy and stability. The RTD sensor is calibrated to measure the temperature of the surface of the sample heating block – giving the closest and most accurate reading of the sample possible. Additional sensor options and alternative sensors, such as a thermistors, are also available.

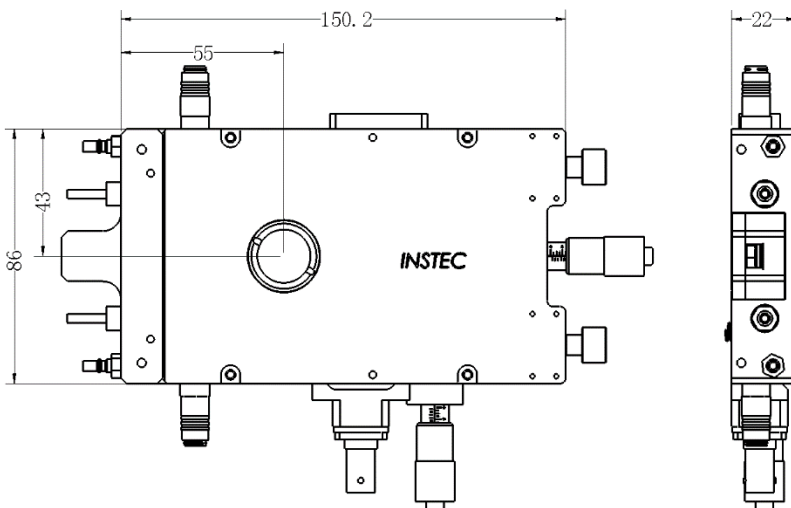

Additional Features

- Includes standalone [mK2000](#) temperature controller
- Includes 'InstecApp' Windows compatible software for optional operation via PC
- Comes standard with optical glass windows that can be easily replaced with IR or UV transparent glass.

THERMAL SPECIFICATIONS

Temperature Control	<i>mK2000</i> with programmable precision switching PID method
Thermal Block	Silver
Sample Thermal Cover	removable Inner sample cover with additional window
Minimum Temperature	-190°C (with optional liquid N2 cooling)
Maximum Temperature	400°C
Temperature Sensor	100 Ω Platinum RTD
Maximum Heating Rate	+100°C per minute at 100°C
Maximum Cooling Rate	-50°C per minute at 100°C
Minimum Heating and Cooling Rate	±0.01°C per minute
Temperature Resolution	0.01°C
Temperature Stability	±0.05°C (>25°C), ±0.1°C (<25°C)
Power supply	Universal power input
Software	Windows software to record and export temperature-time data

OPTICAL SPECIFICATIONS

Optical access	Reflection and transmission capability
Optical windows	Removable and exchangeable windows permit full-spectrum transparency
Minimum Objective Working Distance	5 mm
Minimum Condenser Working Distance	11.5 mm
Top and Bottom Window Aperture	Ø18 mm with Ø22mm Quartz window
Top Viewing Angle	±57.0° from normal
Window Defrost	Integrated external window defrost
Transmission Aperture	Ø2 mm (Ø 4mm option available with HCS621GXY+ model)
Bottom Viewing Angle	±19.0° from normal

STRUCTURAL SPECIFICATIONS

Sample Area	Ø28mm (XY Positioner sample area 15mm x 15mm)
Chamber Height	2.5 mm
Atmosphere Control	Sealed chamber with Gas-purge capability to control humidity, condensation, and oxidation (up to 0.5 Bar positive pressure, 1mBar negative pressure).
Sample Loading	Sample loading requires lid removal
Sample Positioning	10 mm fine travel with Vernier XY dials for remote manipulation in sealed chamber
Frame Cooling	Integrated frame cooling with optional chiller system
Mounting	Base model includes tapped holes on frame and removable side-mounted L-Brackets. Horizontal and vertical mounting adaptors available for select instruments, or by custom design
Frame Dimensions	150mm x 86mm x 22 mm
Weight	1350 g

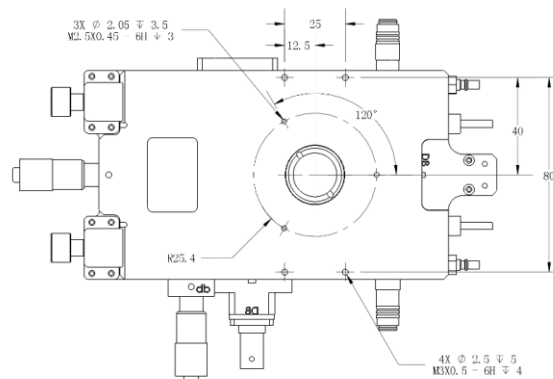

OPTIONS



Active Sample Cooling

Extend lower temperature limit to -190°C with our LN2-P cooling system; includes LN2 suction pump, tubing and Dewar (3L, 10L, or 30L). Enables active sample cooling with rates of up to -50°C per minute (at 100°C).



Frame Cooling

Safety always comes first – keep the frame of the thermal stage cool and safe to touch with an optional water circulator (see [C100W](#)). Frame cooling keeps the outside of the HCS621GXY near room temperature, which prevents frost buildup as the sample is being cooled below freezing temperatures, and also helps to prevent accidental burns.



Sample Fixing Clamps

Secure samples with metal, spring-loaded clamps. Particularly useful in cases where the heating and cooling stage is mounted vertically.

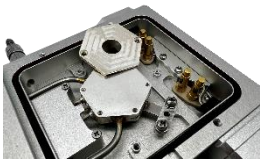

Inner Sample Cover

The chamber height is the distance between the top surface of the thermal block and the bottom surface of the outer cover. With an optional inner cover, the distance is minimized to allow for just enough space for intended samples (slides, slipcovers, wafer pieces, etc.). By closing the distance, vertical temperature gradients are significantly reduced, and sample temperature uniformity is significantly improved.

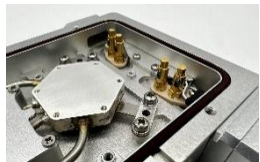

Electrical Feedthroughs

Add up to 2 electrical feedthroughs for applying an electric field to the sample.



Microscope

Entry-level polarizing microscope offering superior performance for a variety of research applications with specifications to satisfy a wide range of demanding observational requirements. (see [TPM-CX40](#))



Microscope Camera with Realtime Temperature Overlay

Integrate digital image acquisition with sample temperature overlay. Includes software (WinDV2 via InstecApp), USB 3.0 connection, 20-megapixel resolution, and standard C-mount microscope connection. (see [MITO2](#))



Mounting Adapters

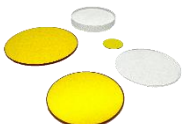

Various mounting adapters are available for most microscope models and/or instruments. Custom mounting adapters may also be made to fit each and every application.



Windows

Additional or alternate available windows are available, such as Sapphire, BaF2, CaF2, ZnSe (see [HCS601GXY-IRM](#) for IR applications).

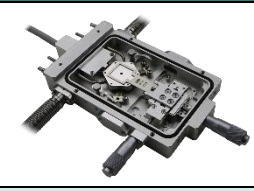
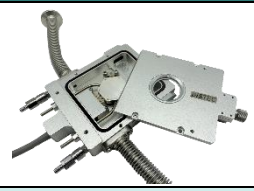
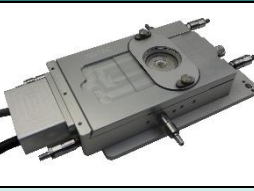
SIMILAR PRODUCTS

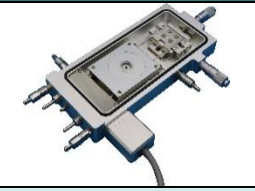
	HCS421VXY	HCP421V	HS1000GXY	TS102VXY	HCS302GXY
					
Temperature Range	-190°C to 400°C	-190°C to 400°C	RT to 1000°C	-40°C to 120°C	-190°C to 400°C
Atmospheric Control	✓	✓	✓	✓	✓
Sample Area	Ø28mm	Ø28mm	16 x 16mm	42mm x 42mm	38mm x 50mm
Sample Cooling	LN2	LN2	- *	TEC	LN2
Thermal Block	Silver	Silver	Silicon Carbide	Anodized Aluminum	Anodized Aluminum
Electrical Feedthroughs	Up to 2	Up to 2	Up to 2	Up to 2	Up to 2
XY Manipulation	✓		✓	✓	✓

*Heating only, no sample cooling available

Other products to consider....



HCP621G heating and cooling plate with Ø28mm sample area. Temperature range -190°C to 600°C. Gas tight chamber with gas purge capabilities. Includes option to add electrical feedthroughs. Has the same temperature range and options, but does not support sample XY movement and does not have a transmission aperture. Highly compatible with reflection-mode optical instruments.



HCS601GXY-IRM FTIR heating and cooling stage with 24mm x 24mm sample area. Temperature Range -190°C to 600°C. Gas tight chamber with gas purge capabilities. CWD=10.5mm WD=10.5mm, cone angle>100°C. Includes IR windows. Has a slightly smaller sample area, and is optimized for IR applications.



HCS350G-TNS heating and cooling stage for tensile force measurements. 26mm x 16mm sample area. Temperature range -190°C to 350°C. Gas tight chamber with gas purge capabilities. Apply up to 200 N force. Specialized for experiments requiring applied force control with simultaneous optical access.

CONTACT A REPRESENTATIVE 